

仅供参考

REV.	REVISION RECORD	DATE
A0	新图面发行	2017.06.16

Specifications:

- Contact resistance: $\leq 20m\Omega$
- Insulation resistance: $\geq 100M\Omega$
- Rated voltage: 125V AC DC
- Rated current: 1.0A AC DC
- Withstand Voltage: 500V AC/minute
- Temperature Range: $-25^{\circ}C \sim +85^{\circ}C$

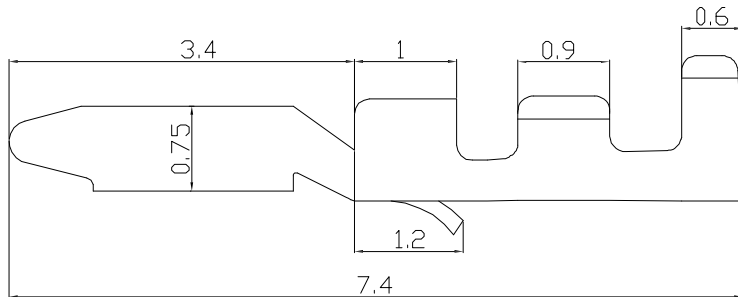
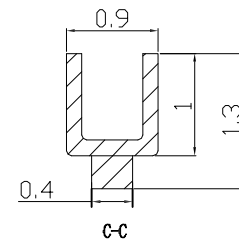
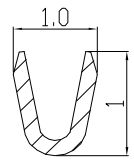
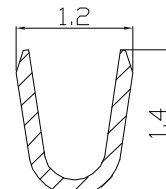
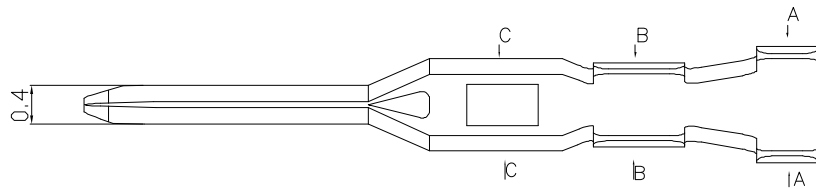
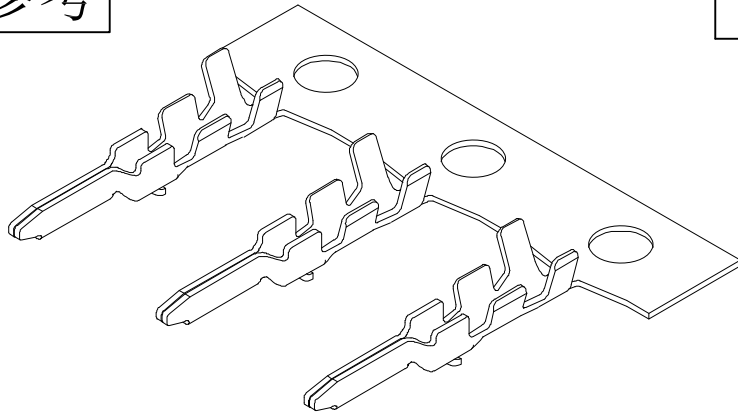

Wire Range	Insulation O. D.	Material	Finish	Qty/Reel
AWG #28~#32	1.00mm (max)	Phosphor bronze	Tin-plated	15000 pcs

	GENERAL TOLERANCES		SCALE: 1:1	NAME	DATE	深圳市思拓展电子有限公司 SHENZHEN SINOTOP ELECTRONICS CO., LTD 公司网址: www.szstuo.cn 公司电话: 0755-23765350 邮箱: 2850175982@qq.com 公司传真: 0755-23765341	PART. NO: ST-WF-125-001RT	
	LINEAR	ANGLES	APPROVED				DWG. NO:	
UNIT: MM	0.00±0.20	X° REF±6°	DESIGNER			TITLE:	REV: A0 SHEET: 1/1	
SIZE: A4	0.000±0.10	X° X'±2°	DRAWN	肖坤权	2017.06.16	1. 2.5mm PITCH TERMINAL		

仅供参考

REV.	REVISION RECORD	DATE
A0	新图面发行	2017.06.16

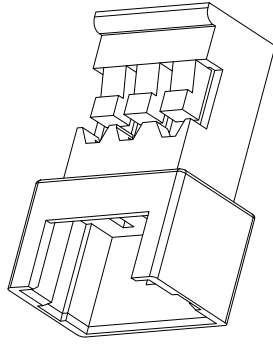

主要技术参数 Main Specifications

- 线数 (Poles): 02 to 16
- 接触电阻 (Contact resistance): $\leq 20m\Omega$
- 绝缘电阻 (Insulation resistance): $\geq 100M\Omega$
- 额定电压 (Rated voltage): 125 V AC DC
- 额定电流 (Rated current): 1.0A AC DC
- 耐电压 (Withstand Voltage): 500V AC/minute
- 温度范围 (Temperature Range): $-25^{\circ}C \sim +105^{\circ}C$

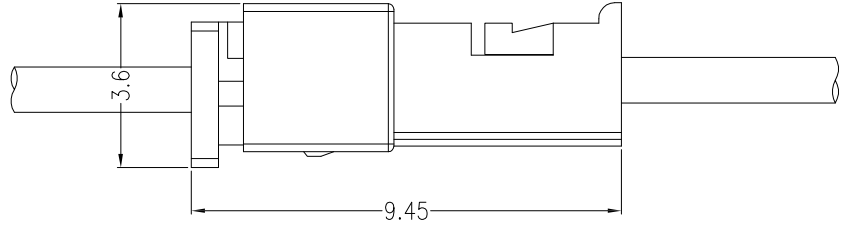

Assembly Layout

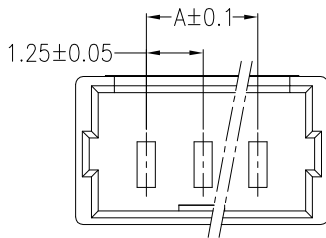
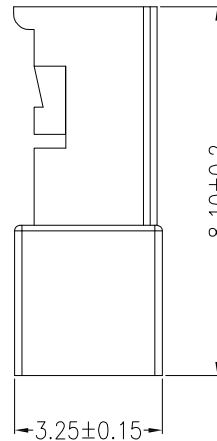
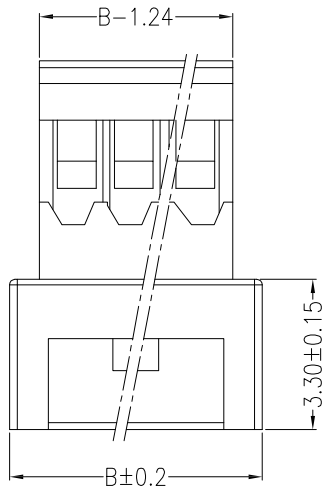

Circuits	Dimensions (mm)	
	A	B
02	1.25	4.20
03	2.50	5.45
04	3.75	6.70
05	5.00	7.95
06	6.25	9.20
07	7.50	10.45
08	8.75	11.70
09	10.00	12.95
10	11.25	14.20
11	12.50	15.45
12	13.75	16.70
13	15.00	17.95
14	16.25	19.20
15	17.50	20.45
16	18.75	21.70

A	HOUSING	1~16 PCS	PA66	COLOR:WHITE
ITFM	COMPONENT	Q'TY	MATERIAL	FINISH

	GENERAL TOLERANCES		SCALE: 1:1	NAME	DATE	深圳市思拓展电子有限公司 SHENZHEN SINOTOP ELECTRONICS CO.,LTD 公司网址: www.szstuo.cn 公司电话: 0755-23765350 邮 箱: 2850175982@qq.com 公司传真: 0755-23765341	PART. NO:
	LINEAR	ANGLES	APPROVED				ST-WF-125-001R
	0.0±0.30	X° REF±6°	DESIGNER				DWG. NO:
	UNIT: MM	0.00±0.20	X° ±3°	DRAWN	肖坤权		2017.06.16
SIZE: A4	0.000±0.10	X° X'±2°	1.25mmPITCH HOUSING			REV: A0	SHEET: 1/1