

仅供参考

REV.	REVISION RECORD	DATE
A0	新图面发行	2017.06.16

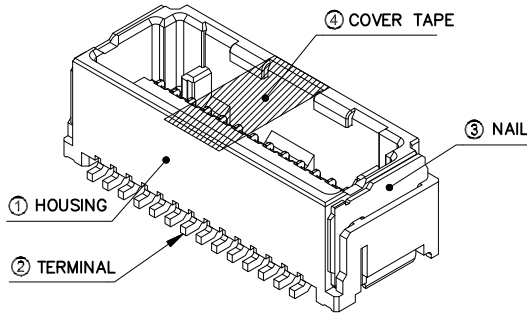

主要技术参数 Main Specifications

- 线数 (Poles): 08 to 42
- 接触电阻 (Contact resistance): $\leq 20m\Omega$
- 绝缘电阻 (Insulation resistance): $\geq 500M\Omega$
- 额定电压 (Rated voltage): 150V AC DC
- 额定电流 (Rated current): 1.0A AC DC
- 耐电压 (Withstand Voltage): 500V AC/minute
- 温度范围 (Temperature Range): $-25^{\circ}C \sim +5^{\circ}C$

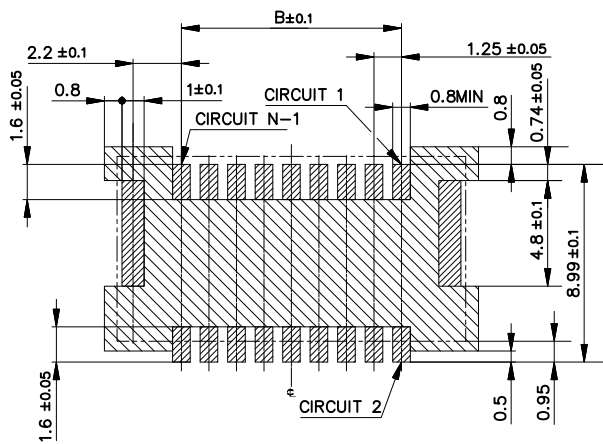
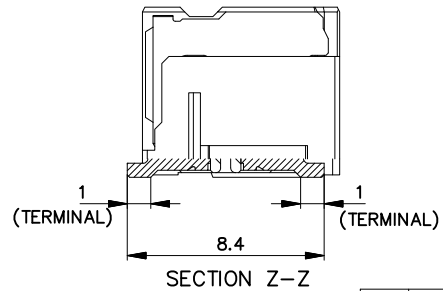
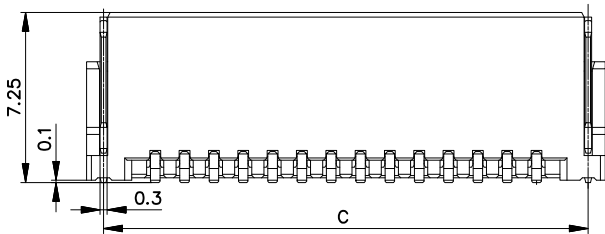
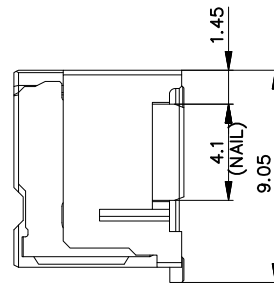
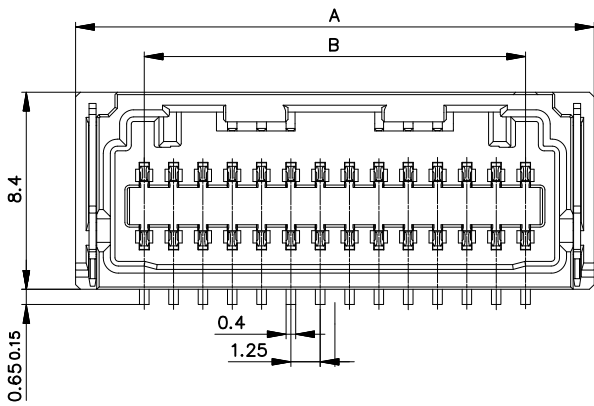
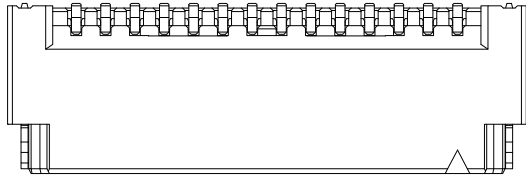

PCB LAYOUT

26.25	29.40	25.00	30.85	42
25.00	28.15	23.75	29.60	40
23.75	26.90	22.50	28.35	38
22.50	25.65	21.25	27.10	36
21.25	24.40	20.00	25.85	34
20.00	23.15	18.75	24.60	32
18.75	21.90	17.50	23.35	30
17.50	20.65	16.25	22.10	28
16.25	19.40	15.00	20.85	26
15.00	18.15	13.75	19.60	24
13.75	16.90	12.50	18.35	22
12.50	15.65	11.25	17.10	20
11.25	14.40	10.00	15.85	18
10.00	13.15	8.75	14.60	16
8.75	11.90	7.50	13.35	14
7.50	10.65	6.25	12.10	12
6.25	9.40	5.00	10.85	10
5.00	8.15	3.75	9.60	8
D	C	B	A	CIRCUIT

NO.	PART	MATERIAL
①	HOUSING	PA UL94 V-0,COLOR: BEIGE
②	TERMINAL	BRASS GOLD PLATING
③	NAIL	BRASS MATTE TIN-BISMUTH PLATING
④	COVER TAPE	PA

	GENERAL TOLERANCES		SCALE: 1:1	NAME	DATE
	LINEAR	ANGLES			
	0.0±0.30	X° REF±6°	APPROVED		
UNIT: MM	0.00±0.20	X° ±3°	DESIGNER		
SIZE: A4	0.000±0.10	X° X'±2°	DRAWN	肖坤权	2017.06.16

深圳市思拓展电子有限公司
 SHENZHEN SINOTOP ELECTRONICS CO.,LTD
 公司地址: www.szstuo.cn 公司电话: 0755-23765350
 邮箱: 2850175982@qq.com 公司传真: 0755-23765341

TITLE:
1.25mmPITCH 180° WAFER SMT TYPE

PART NO:	ST-WF-125-007AWV
DWG NO:	
REV:	A0
SHEET:	1/1

1
2
3
4
5
6
7
8

1
2
3
4
5
6
7
8

A B C D E F G H