

仅供参考

REV.	REVISION RECORD	DATE
A0	新图面发行	2017.06.16

Specifications:

Contact resistance: $\leq 20m\Omega$
 Insulation resistance: $\geq 100M\Omega$
 Rated voltage: 50V AC DC
 Rated current: 2.0A AC DC
 Withstand Voltage: 500V AC/minute
 Temperature Range: $-25^{\circ}C \sim +85^{\circ}C$
 Housing: LCP UL94V-0, Black

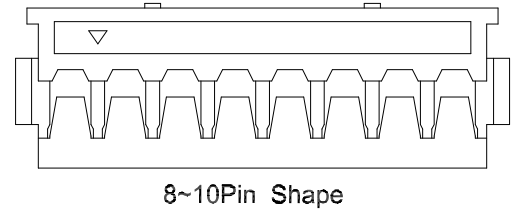
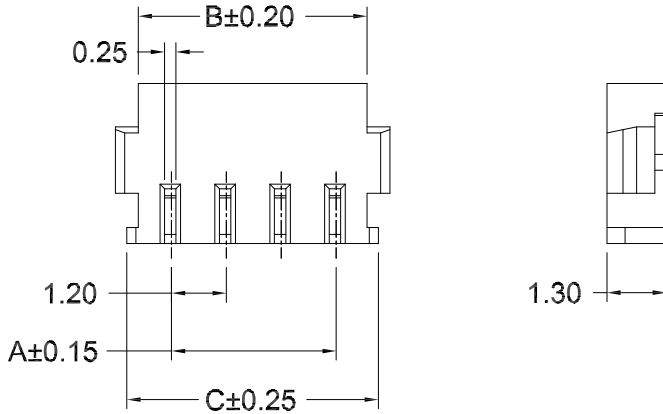
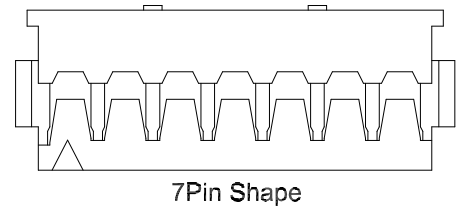
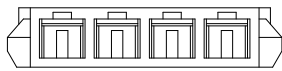
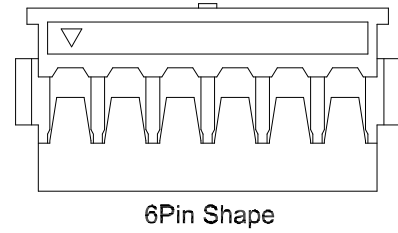
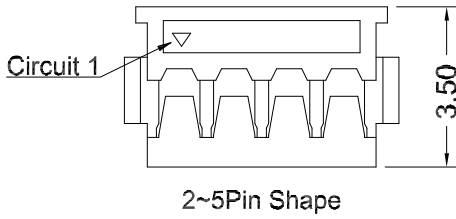
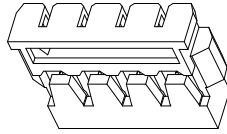

Poles	Dimensions(mm)		
	A	B	C
2	1.20	2.60	3.10
3	2.40	3.80	4.30
4	3.60	5.00	5.50
5	4.80	6.20	6.70
6	6.00	7.40	7.90
7	7.20	8.60	9.10
8	8.40	9.80	10.30
9	9.60	11.00	11.50
10	10.80	12.20	12.70

	GENERAL TOLERANCES		SCALE: 1:1	NAME	DATE	深圳市思拓展电子有限公司 SHENZHEN SINOTOP ELECTRONICS CO., LTD 公司网址: www.szstuo.cn 公司电话: 0755-23765350 邮箱: 2850175982@qq.com 公司传真: 0755-23765341	PART. NO: ST-WF-120-001Y	
	LINEAR	ANGLES					APPROVED	DWG. NO:
UNIT: MM	0.00±0.30	X° REF±6°	DESIGNER	TITLE:	1. 2mm PITCH HOUSING		REV: A0	SHEET: 1/1
SIZE: A4	0.000±0.10	X° X'±2°	DRAWN	肖坤权	2017.06.16			

仅供参考

REV.	REVISION RECORD	DATE
A0	新图面发行	2017.06.16

Specifications:

Contact resistance: $\leq 20m\Omega$
 Insulation resistance: $\geq 100M\Omega$
 Rated voltage: 50V AC DC
 Rated current: 2.0A AC DC
 Withstand Voltage: 500V AC/minute
 Temperature Range: $-25^{\circ}C \sim +85^{\circ}C$

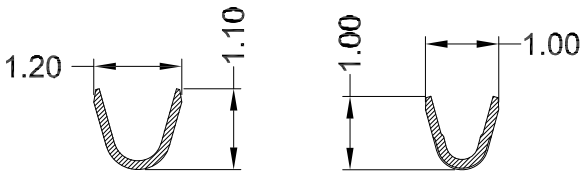
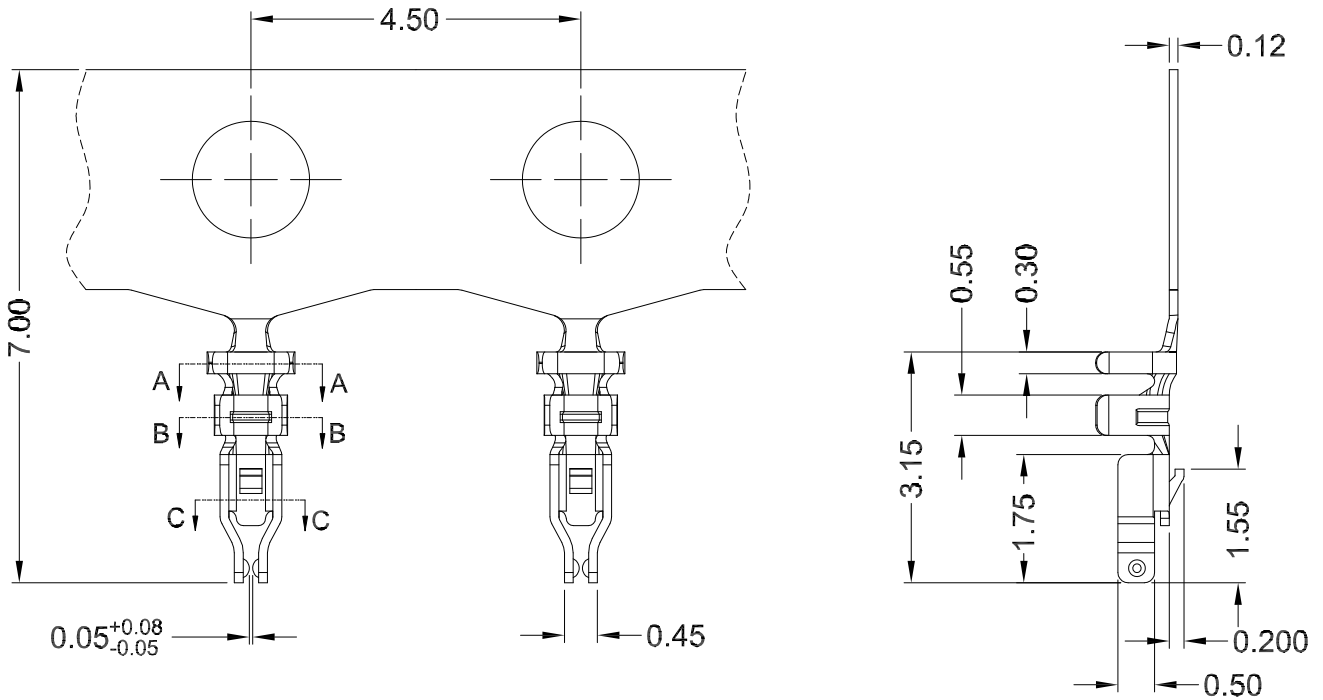

SECTION A-A
SCALE 1:1

SECTION B-B
SCALE 1:1

SECTION C-C
SCALE 1:1

Wire Range	Insulation O. D.	Material	Finish	Qty/Reel
AWG #28~#30	0.70mm (MAX)	Phosphor bronze	Gold Flash	/

	GENERAL TOLERANCES		SCALE: 1:1	NAME	DATE	深圳市思拓展电子有限公司 SHENZHEN SINOTOP ELECTRONICS CO., LTD 公司网址: www.szstuo.cn 公司电话: 0755-23765350 邮箱: 2850175982@qq.com 公司传真: 0755-23765341	PART. NO:
	LINEAR	ANGLES	APPROVED				ST-WF-120-001T
UNIT: MM	0.0 ± 0.30	X° REF ± 6°	DESIGNER			TITLE:	DWG. NO:
SIZE: A4	0.000 ± 0.10	X° X' ± 2°	DRAWN	肖坤权	2017.06.16	1. 2mm PITCH TERMINAL	REV: A0 SHEET: 1/1